

PART NAME

NEMA 4X ENCLOSURE

PART No.

PN-1325, PN-1325-C AND PN-1325-DG

REV. DATE

11-17-08

INDUSTRY STANDARDS:

POLYCARBONATE (LIGHT GRAY AND CLEAR)
UL94-HB FLAMMABILITY RATING (UL FILE #E41613)
UV STABILIZED
SERVICE TEMPERATURE RANGE: -40°C TO +120°C

ABS (DARK GRAY)
UL94-HB FLAMMABILITY RATING (UL FILE #E56070)
SERVICE TEMPERATURE RANGE: -40°C TO +80°C

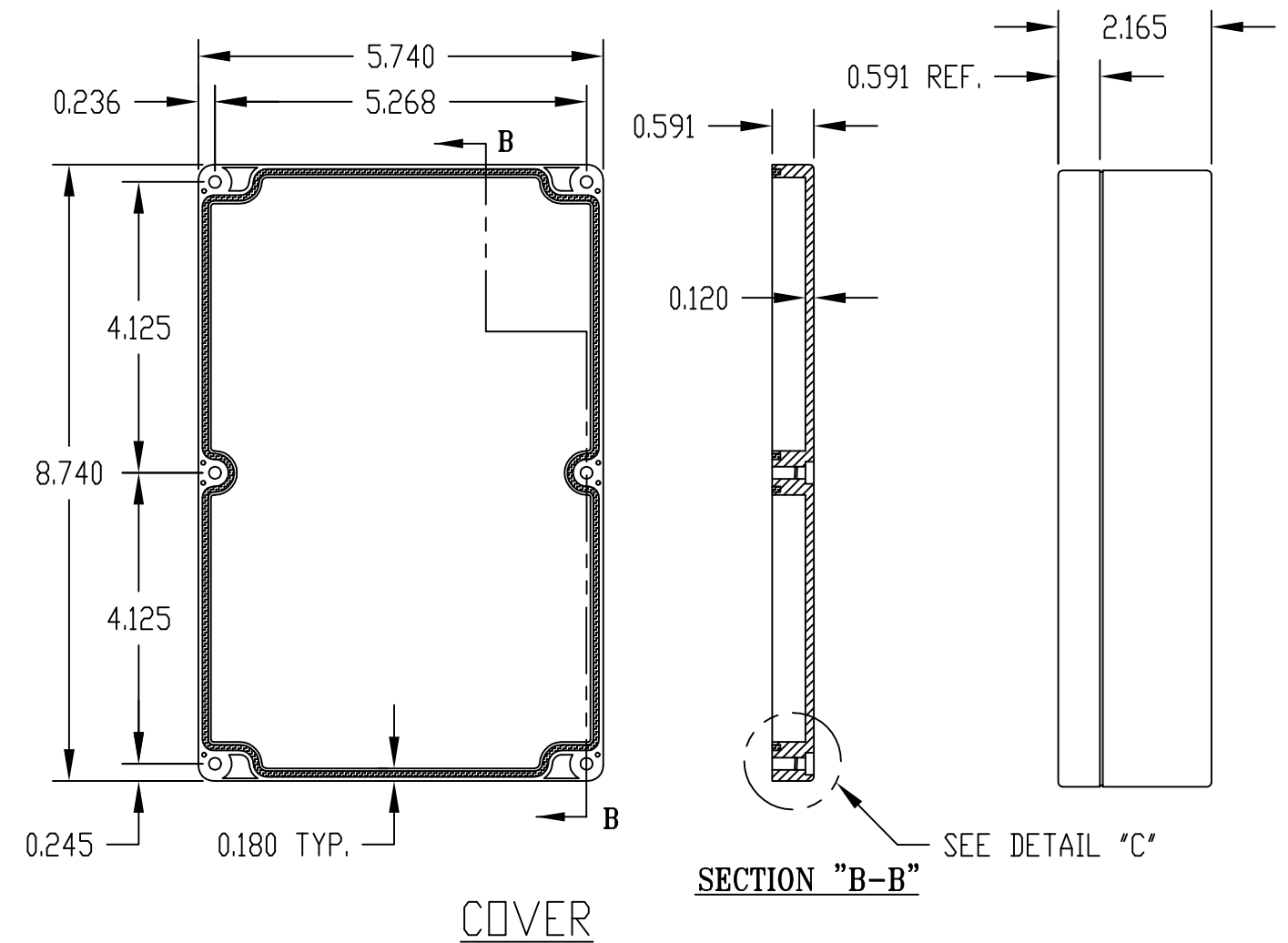
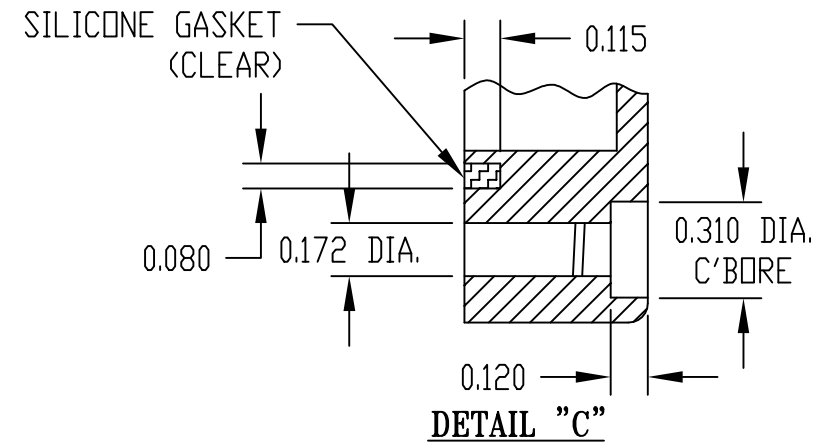
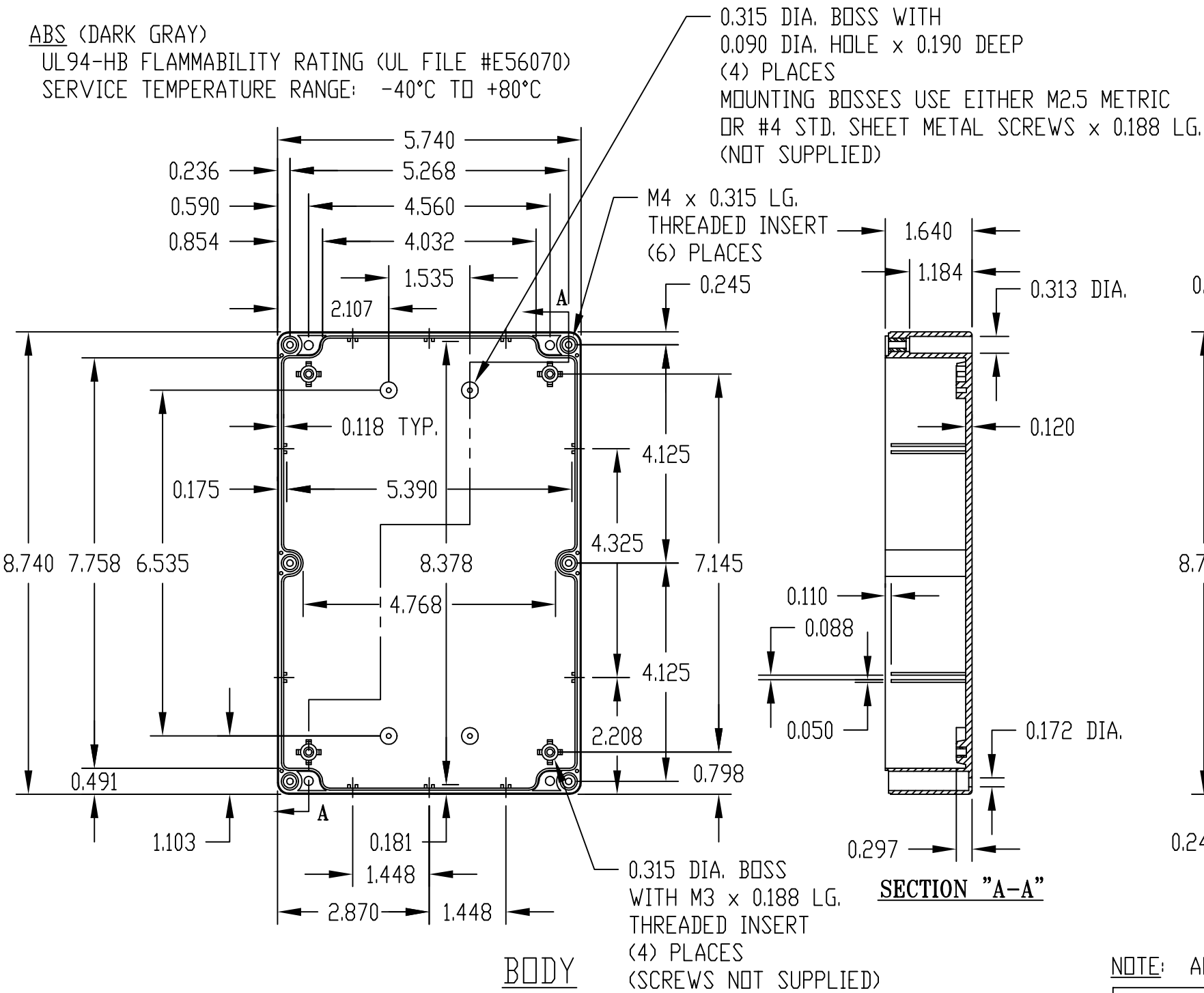

NOTE: ALL DIMENSIONS HAVE ±0.015 TOLERANCE UNLESS OTHERWISE SPECIFIED.

PART NUMBER	MATERIAL		FINISH		HARDWARE KIT
	BODY	COVER	BODY	COVER	
PN-1325	POLYCARBONATE		LIGHT GRAY		KIT CONTAINS (6) M4 x 20mm (0.787") LG. SCREWS FOR ASSEMBLY
PN-1325-C	POLYCARBONATE		LIGHT GRAY	CLEAR	
PN-1325-DG	HIGH-IMPACT ABS		DARK GRAY		